

# **METRO LAWN SPRINKLER SERVICES, LLC**

47917 VANDYKE AVE. SHELBY TOWNSHIP MI 48317

(586) 254-9271 – FAX (586)731-0994

Frequently asked questions and reasons why you should have Metro Lawn Sprinkler Services install your irrigation system. Low bidders are not always the best companies to hire because a cheap price is soon forgotten about when inferior product stays around forever and ends up costing you more in the long run.

Metro Lawn Sprinkler Services has been servicing Southeastern Michigan for over 30 years. We have been a member in a good standing of the Sterling Heights Area Chamber of Commerce since 1988, and also the Better Business Bureau with whom we have a spotless record. We take pride in our work and deliver the best product and service we can to our customers.

## **Design:**

Systems installed by Metro Sprinklers Services have head-to-head coverage, all heads spray away from house and patio, separate zones for shaded areas and sunny areas, and separate rotor zones from mist head zones. All of these things ensure that your lawn will not be too wet or too dry, and will be watered evenly. Systems installed by the competition may mix and match mist heads and rotor heads that have different precipitation rates for shaded and sunny areas on the same zone, which will result in over or under watering of areas.

## **Professionalism:**

Metro Lawn Sprinkler Services makes sure that after every job we install, you are satisfied with the job. We sweep all sidewalks, patios, and driveways of any dirt or debris. We clean and haul away any unused material. Every head is double-checked to be sure that it is straight and adjusted properly. We also leave flags next to the newly installed heads so your sod company can take note of where each and every head is placed. Our equipment is all state of the art, and our business vehicles are all 2003's or newer. Other companies leave the dirt and debris scattered across the property. The heads are left crooked and may not be adjusted at all. A system like this will result in a very unprofessional and unsatisfying experience.

## **Insurance:**

Metro Lawn Sprinkler Services is fully insured and has complete comprehensive and liability coverage for all employees. Some other companies may not have adequate insurance coverage at all. This runs the risk of lawsuit and property damage.

## **Service:**

We have fully staffed office to handle all concerns that you may have. Service crews are separate from installation crews. Our service technicians have the experience and expertise needed to assist you in every concern or need you have with your system. Systems installed by the competitor may not be serviced as a priority. The communication you have with them may be through answering machines. Also, a waiting period, when calls are returned, may exceed days or weeks at a time.



Dear Homeowner,

Metro Lawn Sprinkler Services would like to take the opportunity to announce the addition of a 4-year platinum warranty option for your new sprinkler system.

Our regular warranty includes 2-years on all PARTS against any manufacturer defects provided Metro Lawn Sprinkler Services does the first 2 spring Start-Ups and the first 2 Winterizations, service call and labor rates do apply. The first winterization at a \$55+ dollar value is included with installation of the sprinkler system.

The new platinum warranty option is 4 years from the date of installation. This includes 4 Start-ups and 4 Winterizations, starting at \$450 for a guaranteed savings.

If you would like to add this option to your new sprinkler system warranty, please give us a call.

The regular warranty and the Platinum warranty does not include any timer or head adjustments. Normal rates and fees apply.

Thank You,

Metro Lawn Sprinkler Services





To: Our Customers

Re: Lawn irrigation system backflow preventers

Per the Michigan Plumbing Code, and the Michigan Residential Code, backflow protection may be required for all lawn irrigation systems in your area.

A permit may be required before installation of any backflow prevention assembly. The assembly must then be tested by a certified backflow tester, and a test form submitted before final inspection can be completed.

Thank you,

A handwritten signature in black ink, appearing to read "CHE", is written over the "Thank you," text.

Metro Lawn Sprinkler Services

Parts	Metro Lawn Sprinkler Service	Competition
<b>Timer/Controller</b>	Hunter Pro-C controller or Rainbird products, *digital, 365 day calendar for odd/even schedules, user friendly	Cheaper models: mC3:C39ade to compete with home improvement stores. *not built to last, very difficult to operate
<b>Valves&amp;Manifolds</b>	Schedule 80 PVC threaded tees valves located in plastic valve box on the side of the house, very durable	Poly insert tees & clamps *valve boxes located all over the yard, on some occasions valve boxes made of wood.
<b>Fittings&amp;Clamps</b>	Spears insert fittings connected with swing pipe & stainless steel clamps. allows flexibility & helps set heads at the correct height during installation	Nylon fittings, saddle fittings, nipple connectors & CAD clamps *very rigid & breaks easily
<b>Vacuum Breaker</b>	1" Febco 765*most durable	3/4" vacuum breaker (off brand, cheaper models) *less volume
<b>Pipe</b>	Charter Plastics 1" poly 100 psi 25 year warranty, *better volume pressure	Off brand stock, whatever pipe is the cheapest, 3/4" poly or 80 PSI, *less durable
<b>Shrub Heads</b>	12" pop-up mist heads *not visible, always retract after watering	Nipple risers, *always visible
<b>Wire</b>	18 gauge, heavy duty, direct burial wire (black in color) *thicker wire, never breaks All wire outside or in garage at timer is installed in PVC conduit	22 gauge Thermostat wire (brown in color) *corrodes & breaks easily, exposed wire in garage & outside can be damaged & is unattractive.
<b>Wire Connectors</b>	Water tight gel filled wire nuts, *no corrosion to wire	Electrical tape, dry wire nuts or nothing at all
<b>Plumbing</b>	1" copper pipe *more volume pressure	3/4" copper pipe *less volume & can cause water hammer
	Ball valve shut off *100% closing at the time of winterizing	Gate valve shut off *often leak after a few years of opening and closing
	Proper drains installed *assure no freeze damage after proper winterizing	No drains at all.





## PRESSURE VACUUM BREAKER

### Features

- Available in 1/2" through 2" sizes.
- All bronze body for durability. One check valve and an air opening port in one assembly.
- Lightweight poppet seals air opening under minimum flow conditions.
- Simple service procedures. All internal parts serviceable in line from the top of the unit.
- Designed for minimum head loss.
- Engineered plastic bonnet protect valve bodies from freeze damage.

### Operation

The Febco 765 PVB is designed to be installed to provide protection against backsiphonage of toxic or non-toxic liquids. It consists of a spring loaded check valve which closes tightly when the pressure in the assembly drops below 1 PSI or when zero flow occurs, plus, an air relief valve that opens to break a siphon when the pressure in the assembly drops to 1 PSI.

### Typical Specifications

Pressure Vacuum Breaker assemblies shall be installed to withstand pressure for long periods and to prevent backflow of contaminated water into the potable water system in backsiphonage conditions. The Pressure Vacuum Breaker assembly shall consist of a single spring loaded check valve which closes tightly when water flow through the assembly drops to zero, and a single air relief valve that opens to break the siphon when pressure drops to 1 PSI. The assembly shall include two resilient seated shut-offs and two resilient seated test cocks, considered integral to the assembly. Assemblies must be factory backflow tested. The check valve and air inlet valve must be constructed to allow in-line servicing of the assembly. The valve body shall be constructed of bronze. The check, poppet and bonnet assembly shall be constructed of engineered plastic to protect the valve body from freeze damage.

Pressure Vacuum Breaker assemblies shall be installed a minimum of 12" above the highest downstream outlet, and the highest point in the downstream piping. The assembly shall be rated to 150 PSI working pressure and water temperature from 32°F to 140°F. The assembly shall meet the specifications of the USC\* approval.

Pressure Vacuum Breaker assemblies shall be Febco Model 765 or prior approved equal.

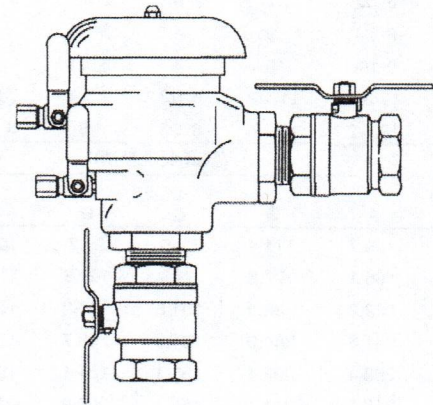

### Typical Applications

PVB assemblies are used to protect against health hazard and non-health hazard backsiphonage conditions in industrial plants, cooling towers laboratories, laundries, swimming pools and lawn sprinkler systems.

### Installation

Pressure Vacuum Breaker assemblies should be installed at least 12" above the highest piping and outlet downstream of the assembly to preclude backpressure. Assemblies should be installed so they are easily accessible for maintenance, periodic testing, and where discharge will not be objectionable. They should be protected from freezing. If the assemblies are subject to freezing temperatures, the freeze protection procedures outlined in "Service Instruction Freeze Protection Model 765" must be followed. Assemblies must not be installed where backpressure could occur.

The discharge pressure shall be maintained above 3.0 PSI on 1/2" through 1-1/4" sizes and 5.0 PSI on 1-1/2" and 2" sizes to insure seating of the spring loaded air inlet poppet.

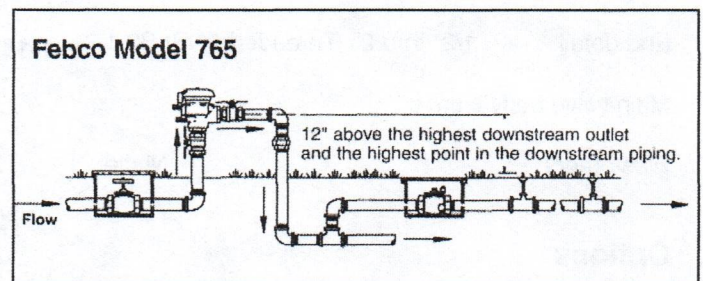

Thermal water expansion and/or water hammer down stream of the backflow preventer can cause pressure increases. Excessive pressure should be eliminated to avoid possible damage to the system and assembly.

\* Approved by the Foundation for Cross-Connection Control and Hydraulic Research at the University of Southern California.



## LNK2™ WiFi Module

### Start Saving When You Add Instant WiFi Connectivity to Your Controller

LNK2 installs in seconds without tools, making it a simple and affordable solution for Rain Bird controllers without built-in WiFi. After a quick setup you'll be able to monitor multiple sites with ease—right from your mobile device—and enjoy advanced water-saving features that save up to 50% in water.

### A Smart & Responsible Solution

#### Optimize Irrigation

Weather data from local weather sources triggers automatic adjusts to run times so your yard only receives the water it needs

#### Conserve Water

Gain access to notifications, Delay Watering, and more advanced features.

#### Manage Remotely

Control irrigation right from your mobile device with NO HIDDEN FEES! Download Rain Bird's FREE App to manage your watering from anywhere in the world.

#### Protect Privacy

LNK2 uses encrypted wireless communication to protect user's privacy.

#### Unlock Voice Control

LNK2 is smart home compatible for convenient, voice-activated control



Visit <https://wifi.rainbird.com/> to learn more.

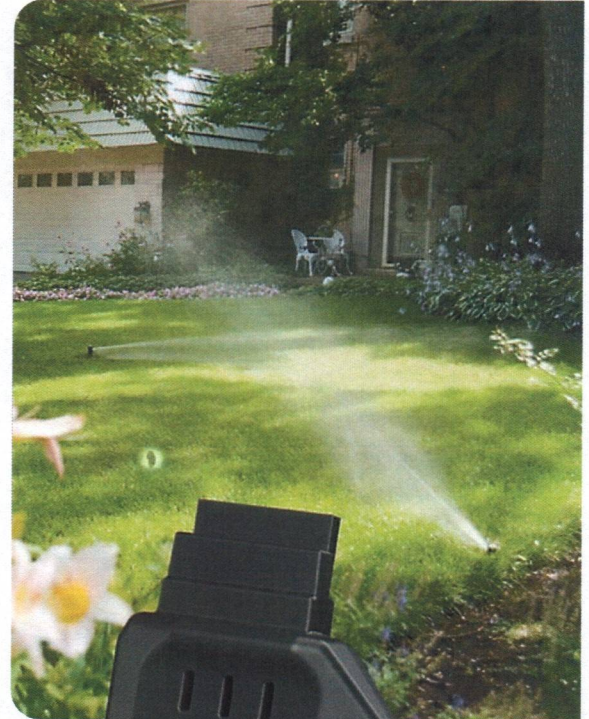





## ► WiFi Ready!

Compatible with the NEW Rain Bird LNK WiFi Module! Simply plug the LNK WiFi Module into the ESP-TM2 accessory port, download the Rain Bird mobile app, and gain access to your irrigation system from anywhere in the world!

## ► 80 Years of Experience

Rain Bird's stellar reputation of providing high quality irrigation products for over 80 years delivers again with the ESP-TM2, carrying a 3 year trade warranty.

## ► Simple to Program

The ESP-TM2 is simple to program and use with Rain Bird's Extra Simple Programming. Easily customize your schedule to keep your landscapes lush!

## ESP-TM2 Tract Model 2nd Generation

*Simple, flexible, reliable*



The ESP-TM2 irrigation controller is the perfect option for basic residential solutions. Building upon Rain Bird's legacy of The Intelligent Use of Water, this controller offers simple water saving features that you will actually use.

With the flexibility of 3 programs and 4 start times available per program you can tailor your watering schedule to your landscape's needs. The ESP-TM2 provides the Extra Simple Programming interface you are familiar with in a controller that is built to last!



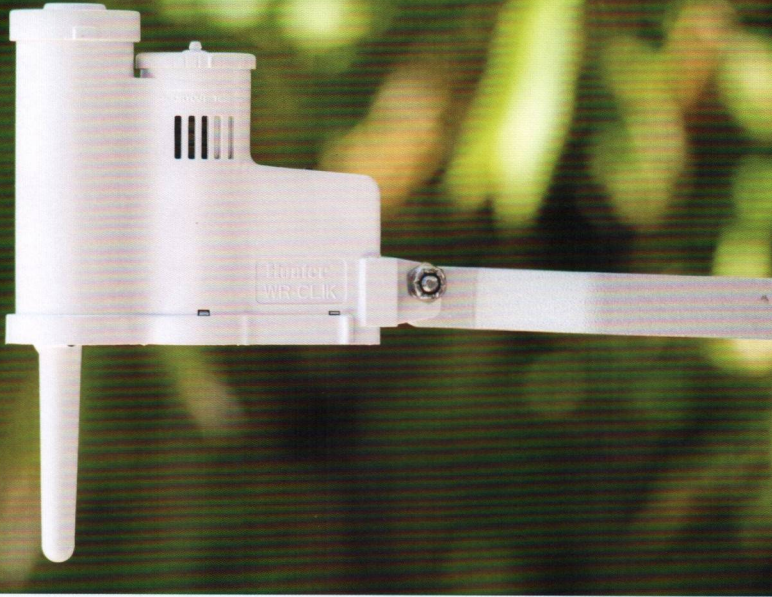

- 01 **Easy:** Fast, simple installation for both wired and wireless models
- 02 **Versatile:** Compatible with all Hunter AC controllers
- 03 **Smart:** Shuts down irrigation the moment rain is detected

## RAIN-CLIK® SENSORS

### *Rain-Clik's Quick Response™ Stops Irrigation the Instant Rain Starts to Fall*

Most rain-sensing devices work by accumulating a set amount of rainfall before a switch is activated that interrupts the circuit from the controller and shuts off the system. In that “accumulation time”, the system will unnecessarily continue to water. This can look especially bad for conservation-conscious municipalities, businesses, and residences. With built-in Quick Response technology, the Hunter Rain-Clik and Wireless Rain-Clik can command a controller to shut off right when it starts to rain. The Rain-Clik can be mounted on an eave or any flat vertical surface like a wall or fence. A gutter mount is also available that allows for easy installation of the Rain-Clik on the edge of a gutter.



# 3/4" PGP® ULTRA AND I-20 ROTORS

The professional's choice for reliability

## KEY BENEFITS

### Automatic Arc Return

The patented automatic arc return resets the turret to the original arc, regardless of where it is turned, ensuring vandal protection in any environment.

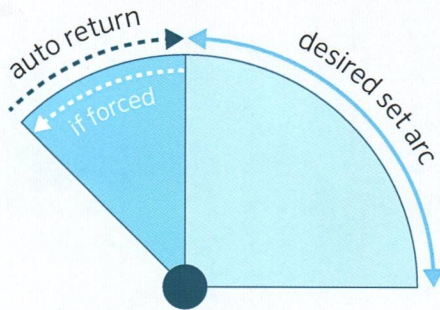

### Non-Strippable Drive

The patented, vandal-proof drive mechanism offers reliable protection against internal gear damage.

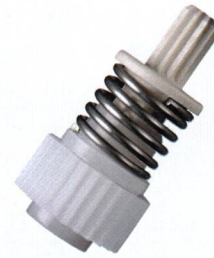

### FloStop® Technology (only I-20)

Service and install the I-20 with ease using FloStop to shut off the flow of water from the rotor.



### Complete Arc Adjustment

Adjust from 50° to a non-reversing 360° for flexibility across all landscapes and reduced inventory.

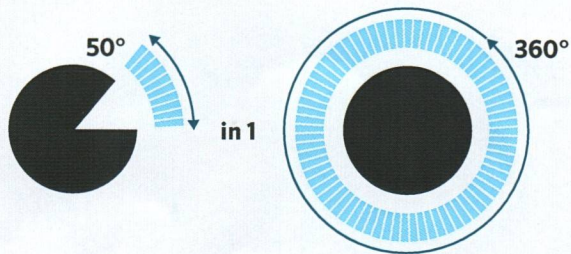

### Drain Check Valve

Stop runoff with a standard check valve in the I-20 and PGP-CV (up to 10') or field-installable (up to 3') for PGP Ultra.



<https://hunter.info/Rotors>

# Hunter®



## IN THE FIELD

- 1 **Issue:** I can't adjust the nozzle retainer screw with debris inside the socket.

**Solution:** The PGP Ultra and I-20 rotors have a headed and slotted nozzle retainer screw, allowing the use of a small, slotted screwdriver or the Hunter wrench for easy adjustments as needed.



- 2 **Issue:** Water seems to leak from the lowest sprinkler after the zone shuts off.

**Solution:** The PGP Ultra offers a field-installable drain check valve that can replace the normal filter screen. The check valve is a good solution in fairly flat landscapes, helping to prevent low-head drainage.

- 3 **Issue:** I need to customize my irrigation system for perfect coverage.

**Solution:** Each sprinkler comes with a rack of eight easy-to-install, flat-top standard nozzles, along with four low-angle nozzles. Racks of 18-25' short-range nozzles and MPR (matched precipitation rate) nozzles with a radius of 25', 30', or 35' are also available.

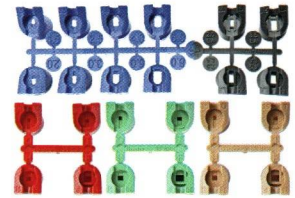

- 4 **Issue:** Water leaks from under the body cap of my old PGP rotors, but the newer ones seem to be OK.

**Solution:** The no-flow-by PGP riser seal is made from a high-tech material introduced several years ago with flawless performance. All Hunter rotors are designed with a removable, replaceable wiper seal, so even an older head can take advantage of this innovative new material.



Riser seal part # 181500

## IN THE DESIGN OFFICE

- 4" and 6" stainless steel I-20 models deliver consistent performance, even in harsh environments (figure 1).
- For maximum water efficiency, add 40 PSI pressure regulation (figure 2, figure 3).
- Purple identification markers are available for reclaimed water applications (figure 1).
- Choose from a wide nozzle selection for complete design flexibility, including short-radius and MPR choices.
- Tested in our ISO Certified Test facility, ensuring top-quality product for years to come.







## ► Unmatched Reliability

Constructed of time-proven UV-resistant plastic and corrosion resistant stainless steel parts, assuring long product life.

## ► Maximum Compatability

Designed for use with all Rain Bird spray head nozzles including Rotary, R-VAN, U-Series, MPR, HE-VAN, VAN, and SQ Series nozzles.

## ► Water Saving Features

Available options like a Seal-A-Matic™ (SAM) check valve and a patented PRS in-stem pressure regulator increase efficiency by eliminating wasted water.

## 1800® Series Spray Heads

*The #1 irrigation spray head in the world*



Installed in parks and backyards across the globe, Rain Bird's 1800 Series is the #1 irrigation spray head brand in the world.

Chosen for its reliability, heavy-duty materials and versatility, the 1800 Series has first-rate quality built in for reliable operation and long life. Their superior components and features make them the spray heads of choice for a wide variety of applications.

Also available with a Seal-A-Matic™ (SAM) check valve option and a patented PRS in-stem pressure regulating option.





- 01 **Hardworking:** Built to last in the elements and work flawlessly for years
- 02 **Versatile:** Available in an array of configurations to fit virtually any system
- 03 **Practical:** Low-flow capabilities for compatibility with Hunter micro irrigation products



All Hunter valves are 100% water-tested to ensure reliable operation once installed.

## PGV 1" VALVE

### *Professional-Grade Valves for Common Landscape Applications*

When the job calls for a hardworking, dynamic valve that performs flawlessly every day, the 1" PGV Valve is the answer. Built to handle the rigors of most residential and light commercial sites, the highly durable PGV is available in an array of configurations. For smaller landscape applications, the PGV is available in four 1" designs: globe, angle, male x male, or male x barb. Each model is available with optional built-in flow control.

#### PGV Jar-Top Valves

All it takes is a simple twist of the wrist to unscrew the top of the valve for the fastest service in the industry.



Learn more. Visit [hunterindustries.com](http://hunterindustries.com) or contact your local sales manager.



# PGV 1" VALVE KEY BENEFITS & SPECIFICATIONS

## Key Benefits

- External/internal manual bleed allows for quick and easy activation at the valve
- Double-beaded diaphragm seal design ensures leak-free performance
- Captive bonnet screws eliminate the possibility of lost parts during disassembly
- Triple-tool bonnet screws are compatible with standard or Phillips screwdrivers as well as a nut driver
- Jar-top models provide easy access without tools
- Encapsulated solenoid with captive plunger used on every Hunter valve provides hassle-free service
- Flow control maximizes efficiency and prolongs the life of the system

## User-Installed Options

- Accu Sync® Pressure Regulators to maximize water savings
- DC-latching solenoid for battery-powered controllers

## Operating Specifications

- Flow: 0.2 to 40 GPM
- Recommended pressure range: 20 to 150 PSI
- Temperature rating: 150°F
- Warranty period: 2 years

## Solenoid Specifications

- 24 VAC solenoid
  - 350 mA inrush, 190 mA holding, 60 Hz
  - 370 mA inrush, 210 mA holding, 50 Hz

### PGV PRESSURE LOSS IN PSI

GPM	Globe	Angle	Male x Male	Male x Barb
1	3	1	2	2
5	4	1	2	2
10	4	1	2	2
15	5	1	3	3
20	5	2	4	4
25	6	2	7	6
30	8	3	10	10
40	14	5	18	16

## Models

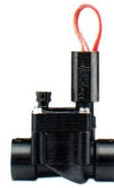

**PGV-100G**  
Inlet Diameter: 1"  
5" H x 4½" L x 2½" W

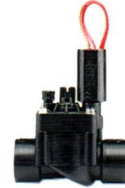

**PGV-101G**  
Inlet Diameter: 1"  
5" H x 4½" L x 2½" W



**PGV-100JT - G**  
Inlet Diameter: 1"  
5½" H x 4½" L x 3¼" W



**PGV-101JT - G**  
Inlet Diameter: 1"  
5½" H x 4½" L x 3¼" W

### PGV 1" VALVES

Model	Description
PGV-100G PGV-100JT-G	1" plastic globe valve, female thread
PGV-100G-S PGV-100JT-G-S	1" plastic globe valve, slip x slip
PGV-101G PGV-101JT-G	1" plastic globe valve with flow control, female thread
PGV-101G-S PGV-101JT-G-S	1" plastic globe valve with flow control, slip x slip
PGV-100A	1" plastic angle valve
PGV-101A	1" plastic angle valve with flow control
PGV-100-MB PGV-100JT-MB	1" plastic globe valve, male thread x 1" barb
PGV-100-MB-125 PGV-100JT-MB-125	1" plastic globe valve, male thread x 1¼" barb
PGV-101-MB PGV-101JT-MB	1" plastic globe valve, with flow control, male thread x 1" barb
PGV-101-MB-125 PGV-101JT-MB-125	1" plastic globe valve, with flow control, male thread x 1¼" barb
PGV-100-MM PGV-100JT-MM	1" plastic globe valve, male x male thread
PGV-101-MM PGV-101JT-MM	1" plastic globe valve, with flow control, male x male thread

Website [hunterindustries.com](http://hunterindustries.com) | Customer Support 1-800-383-4747 | Technical Service 1-800-733-2823

Helping our customers succeed is what drives us. While our passion for innovation and engineering is built into everything we do, it is our commitment to exceptional support that we hope will keep you in the Hunter family of customers for years to come.